

SERIE MILLENNIUM

Vidrio 10 mm

AISI-316

PERNIO ALTO REGULABLE

160 x 45 mm

Acabados:

Inox brillo	4140.TR IB
Inox mate	4140.TR IM

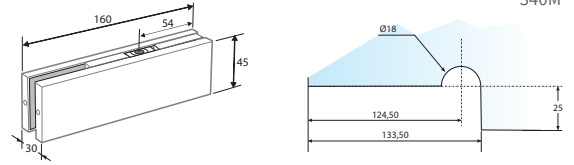

323M
340M

DESPLAZADO

Acabados:

Inox brillo	4150.TR IB
Inox mate	4150.TR IM

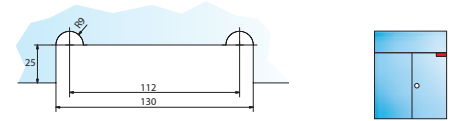

PERNIO BAJO REGULABLE REGLETA (CE)

160 x 45 mm

Medida máxima puerta: 2500 x 1100 mm

Peso máximo puerta: 70 kg

Acabados:

Inox brillo	4141.TR IB
Inox mate	4141.TR IM

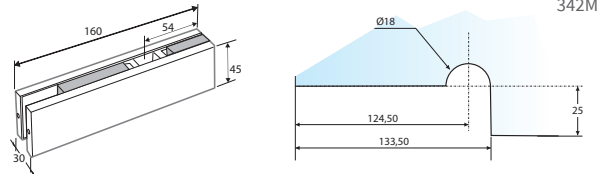
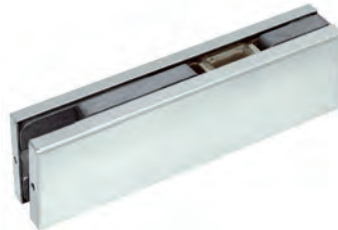

325M
342M

*Muesca desplazada de la serie milenium:

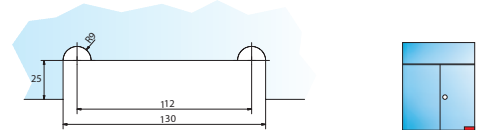

DESPLAZADO

Acabados:

Inox brillo	4151.TR IB
Inox mate	4151.TR IM

PERNIO BAJO REGULABLE CUADRADILLO FRANCÉS

160 x 45 mm

Acabados:

Inox brillo	4141.1TR IB
Inox mate	4141.1TR IM

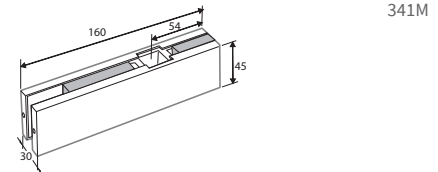

324M
341M

DESPLAZADO

Acabados:

Inox brillo	4151.1TR IB
Inox mate	4151.1TR IM

PERNIO BAJO REGULABLE EJE ALEMÁN

160 x 45 mm

Acabados:

Inox brillo	4141.2TR IB
Inox mate	4141.2TR IM

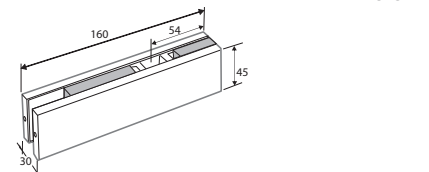

326M
343M

DESPLAZADO

Acabados:

Inox brillo	4151.2TR IB
Inox mate	4151.2TR IM

PUNTO DE GIRO SUPERIOR

114 x 25 mm

Para Ref. 4140.TR

Acabados:

Inox brillo	4168.TR IB
Inox mate	4168.TR IM

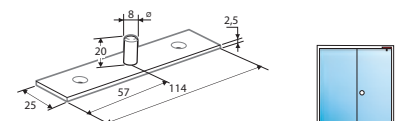

329M



Vidrio 10 mm AISI-316

PERNIO ALTO
160 x 45 mm

Acabados:

Inox brillo	4140.T IB
Inox mate	4140.T IM



301M

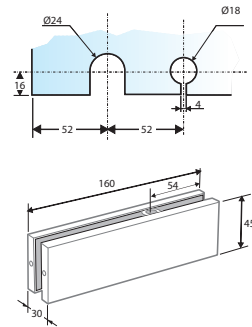

PERNIO BAJO REGLETA
160 x 45 mm (CE)

Medida máxima puerta: 2500 x 1100 mm

Peso máximo puerta: 70 kg

Acabados:

Inox brillo	4141.T IB
Inox mate	4141.T IM



302M

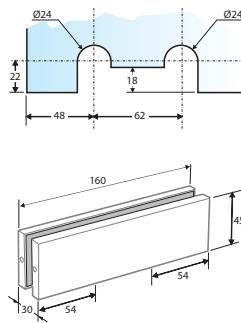

PUNTO DE GIRO SUPERIOR
114 x 25 mm

Para Ref. 4140.T

Acabados:

Inox brillo	4168.T IB
Inox mate	4168.T IM



303M

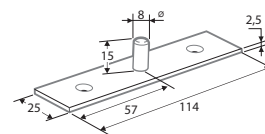

PUNTO DE GIRO MONTANTE
165 x 45 mm

Acabados:

Inox brillo	4160.T IB
Inox mate	4160.T IM



304M

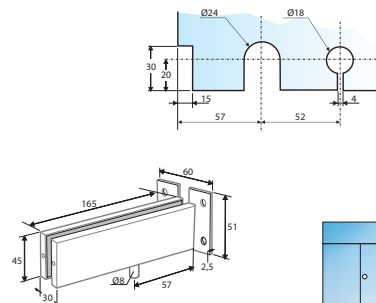

PUNTO DE GIRO MONTANTE DESPLAZADO
160 x 45 mm

Acabados:

Inox brillo	4162.T IB
Inox mate	4162.T IM

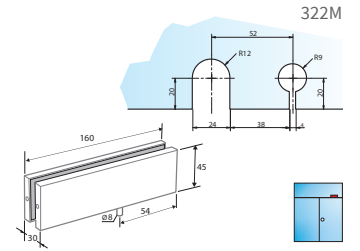

PUNTO DE GIRO MONTANTE DOBLE EN BATERÍA DE PUERTAS
320 x 45 mm

Acabados:

Inox brillo	4164.T IB
Inox mate	4164.T IM

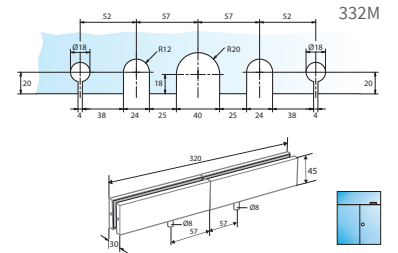

PUNTO DE GIRO LATERAL MONTANTE
210 x 95 mm

Acabados:

Inox brillo	4165.T IB
Inox mate	4165.T IM

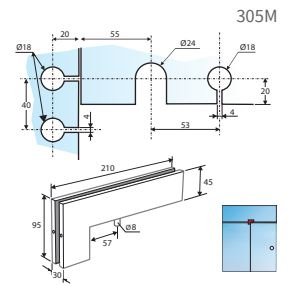

PUNTO DE GIRO LATERAL MONTANTE 90°
178 x 95 mm

Acabados:

Inox brillo	4165.1T IB
Inox mate	4165.1T IM

* Indicar mano

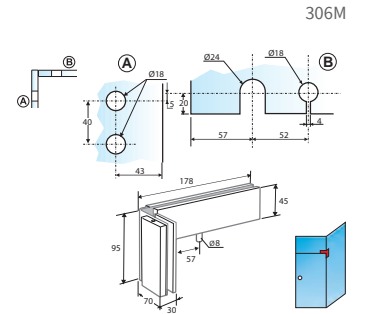

PUNTO DE GIRO LATERAL MONTANTE CON CONTRAFUERTE
210 x 95 mm

Acabados:

Inox brillo	4163.T IB
Inox mate	4163.T IM

* Indicar mano

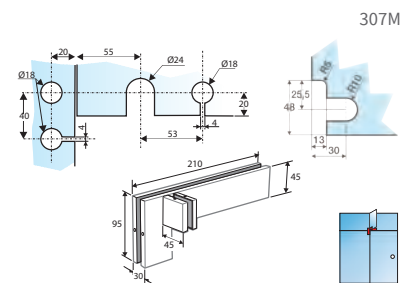

FIJO UNA LUNA
45 x 45 mm

Acabados:

Inox brillo	4175.T IB
Inox mate	4175.T IM

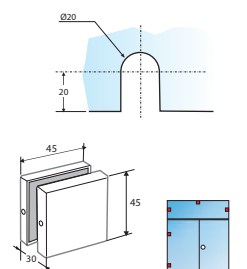



Vidrio 10 mm

AISI-316

UNIÓN DOS LUNAS

95 x 45 mm

Acabados:

Inox brillo	4179.T IB
Inox mate	4179.T IM

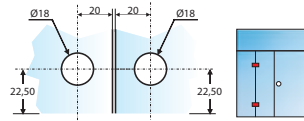
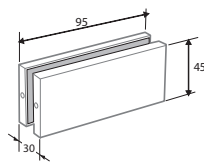

309M

UNIÓN DOS LUNAS VERTICAL

95 x 45 mm

Acabados:

Inox brillo	4178.T IB
Inox mate	4178.T IM

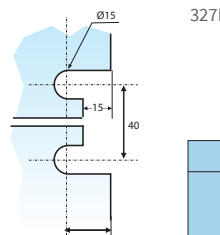
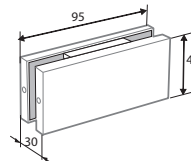

327M

UNIÓN DOS LUNAS TOPE

95 x 45 mm

Acabados:

Inox brillo	4080.T IB
Inox mate	4080.T IM

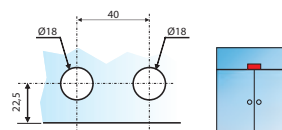
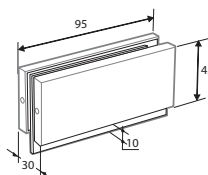

310M

UNIÓN DOS LUNAS 90°

70 x 45 mm

Acabados:

Inox brillo	4180.T IB
Inox mate	4180.T IM

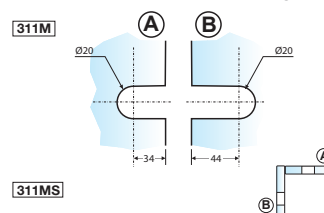
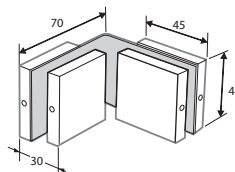

311M
311MS

UNIÓN DOS LUNAS 90°

SUELO/TECHO

Acabados:

Inox brillo	4180.1T IB
Inox mate	4180.1T IM

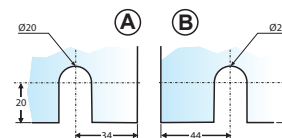

UNIÓN DOS LUNAS CON CONTRAFUERTE

95 x 45 mm

Acabados:

Inox brillo	4181.T IB
Inox mate	4181.T IM

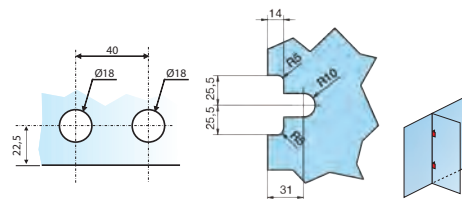
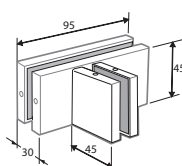

312M

UNIÓN TRES LUNAS

95 x 95 mm

Acabados:

Inox brillo	4184.T IB
Inox mate	4184.T IM

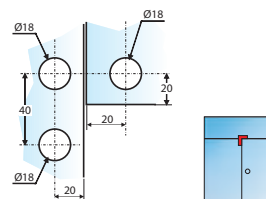
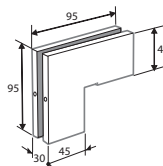

314M



Vidrio 10 mm

AISI-316

UNIÓN CUATRO LUNAS

95 x 95 mm

Acabados:

Inox brillo	4186.T IB
Inox mate	4186.T IM

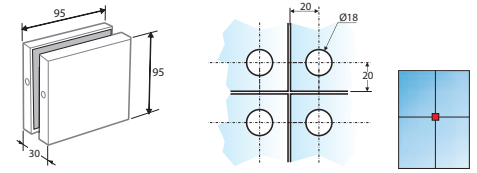

320M

PERNIO ALTO GIRO DESPLAZADO

160 x 45 mm

Acabados:

Inox brillo	4143.T IB
Inox mate	4143.T IM

* Indicar mano

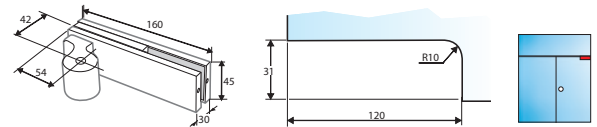

334M

PERNIO BAJO CUADRADILLO FRANCÉS

GIRO DESPLAZADO

160 x 45 mm

Acabados:

Inox brillo	4144.T IB
Inox mate	4144.T IM

* Indicar mano

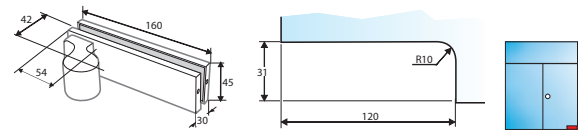

333M

PUNTO DE GIRO MONTANTE

GIRO DESPLAZADO

160 x 45 mm

Acabados:

Inox brillo	4167.T IB
Inox mate	4167.T IM

* Indicar mano

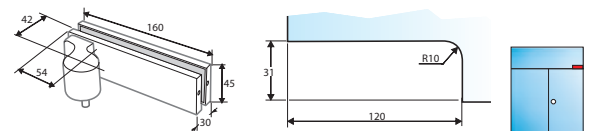

335M

PUNTO DE GIRO LATERAL MONTANTE

GIRO DESPLAZADO

210 x 95 mm

Acabados:

Inox brillo	4166.T IB
Inox mate	4166.T IM

* Indicar mano

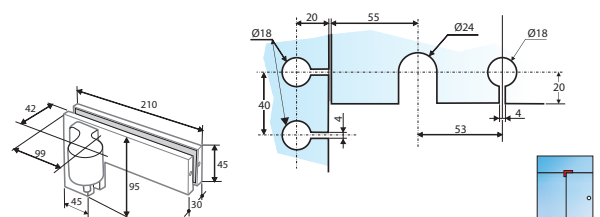

336M